







SANUS®

LEARN MORE

 www.sanus.com  m.sanus.com  [SanusSystems](https://www.facebook.com/SanusSystems)  [SanusSystems](https://twitter.com/SanusSystems)  [Sanus](https://www.youtube.com/Sanus)

© 2015 Milestone AV Technologies, a Pritzker Group Company. All Rights Reserved. SANUS and the SANUS Logo are registered trademarks of Milestone. All other brand names or marks are used for identification purposes and are trademarks of Milestone. All patents are protected under existing designations. Other patents pending. All information and designs contained are proprietary property of Milestone AV and may not be reproduced without express written consent of Milestone AV Technologies.

info@sanus.com | PHONE 800.359.5520 | FAX 651.636.0367

**PREMIUM TV WALL MOUNTS
AND AV ACCESSORIES**

REIMAGINE YOUR SPACE WITH SANUS AND GENEVIEVE GORDER

4 tips to update your space from celebrity interior designer Genevieve Gorder

Visualize Your Style

Before starting to transform your space, think about how you want your space to function for you; the layout of a space dictates how one should behave in that space. Therefore it is crucial that the layout fits the mood you are trying to capture.

Maximize Your Space

Mount your TV with a SANUS mount to maximize space without compromising the look and feel of a room; ideal for any interior design layout, SANUS offers a complete line of TV mounting solutions that will instantly add a modern feel to any room.

Create a Safe Environment for Kids

Eliminate the risk of TV tip-overs by removing your old TV stand and mounting your TV to the wall, ensuring a safe and stylish home year-round.

Eliminate Window Glare

If windows are getting in the way of your interior design layout, mount your TV with a full-motion mount to achieve perfect viewing from any seat in the room.



genevieve gorder
Celebrity Interior Designer



INSTALLATION IS A BREEZE IN 3 EASY STEPS

Matching a TV to a mount and installing may seem daunting, but with well-designed and easy-to-install products, setting up a SANUS mount has never been simpler. SANUS wall mounts offer tool-less assembly and an easy-to-follow instruction manual, which means you spend less time fussing with installation.

WE'VE INCLUDED NEW TOOLS TO MAKE INSTALLATION EVEN EASIER

Installation is made even simpler by including almost everything you'll need for a smooth setup. You'll love our simplified and organized hardware, magnetic stud finder, and wall template that shows you exactly where to drill.

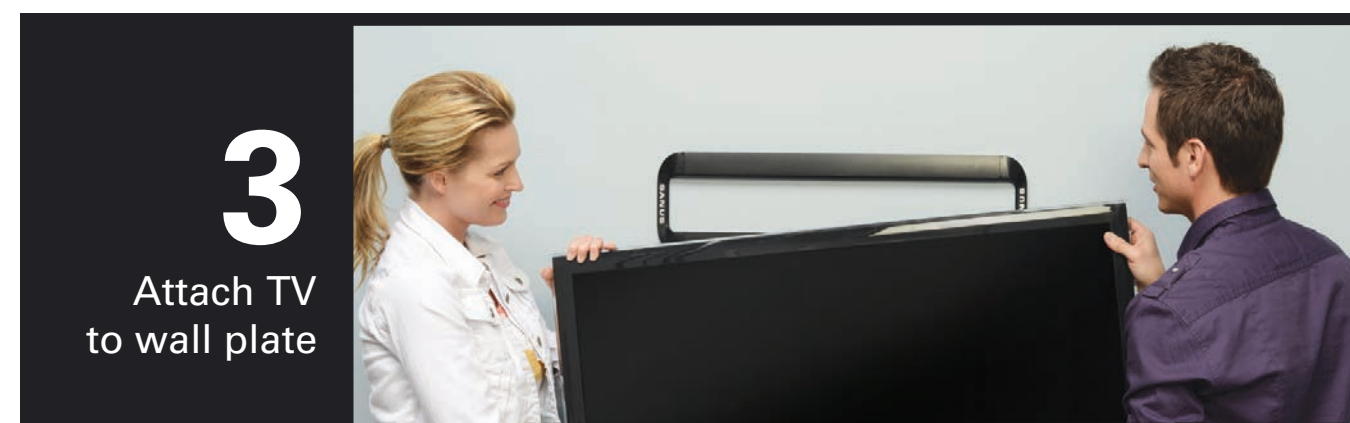
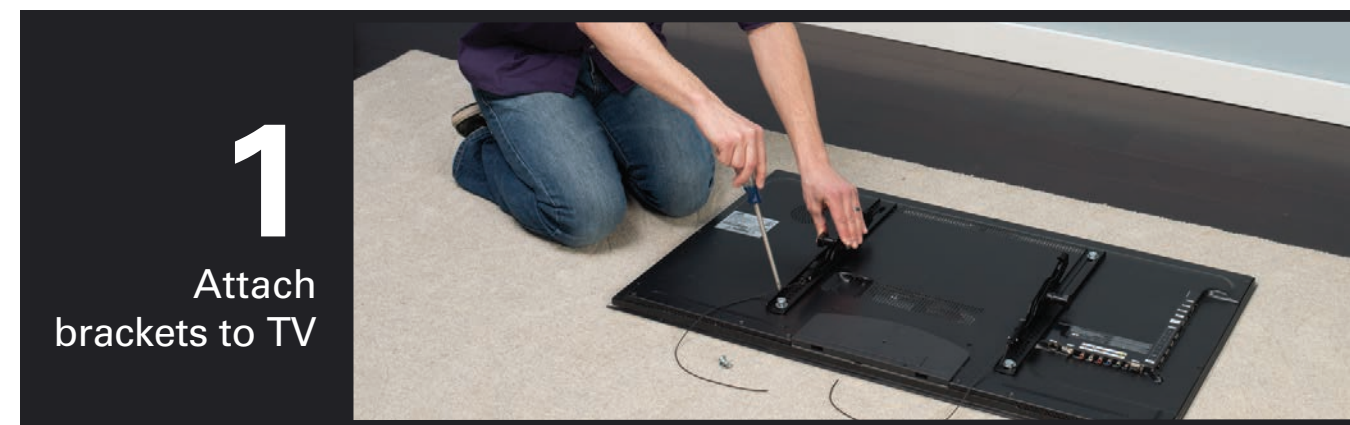

Included hardware eliminates unnecessary trips to the store to buy additional pieces

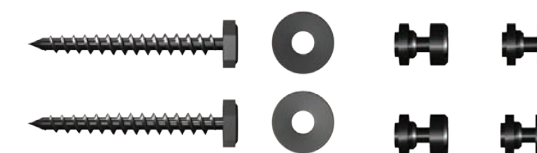

Magnetic stud finder finds the perfect spot to mount your TV



Wall template shows you where to drill



SANUS PREMIUM TV WALL MOUNTS

SANUS Premium wall mounts are the perfect union of form and function with high-quality materials and an elegant, high-end design



VLF525 | 51"-70"

Weight Capacity 125 lbs.

- ↳ Wall Mount Tilts -15°/+5°
- ↳ Wall Mount Swivels ±90°
- ↳ Distance from Wall 3.6"
- ↳ Extends 25" from Wall
- ↳ Product Width 30.8"
- ↳ Product Height 18.6"
- ↳ Product Depth 3.6"-25"
- ↳ Level Adjustment ±3°



1 Tool-free mount assembly ensures a quick installation



2 Organize and conceal unsightly cables



3 Locking lever easily secures mount and audible click means mounting is complete



4 For perfect positioning on the wall, slide TV side to side



5 Decorative cover hides hardware for a finished look



FULL-MOTION+

Adds tilt & extra swivel for reduced glare and the best view from any seat in the room

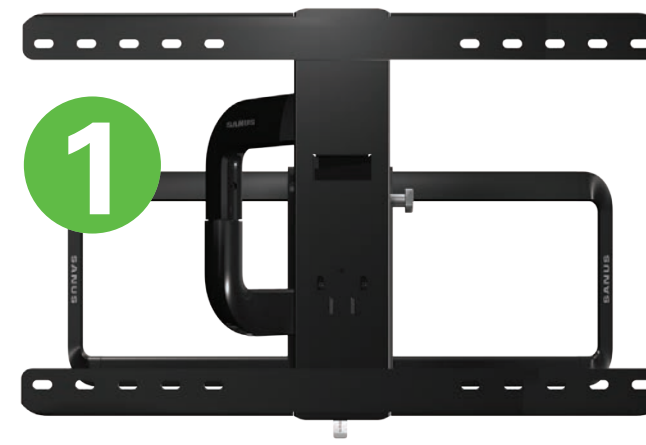
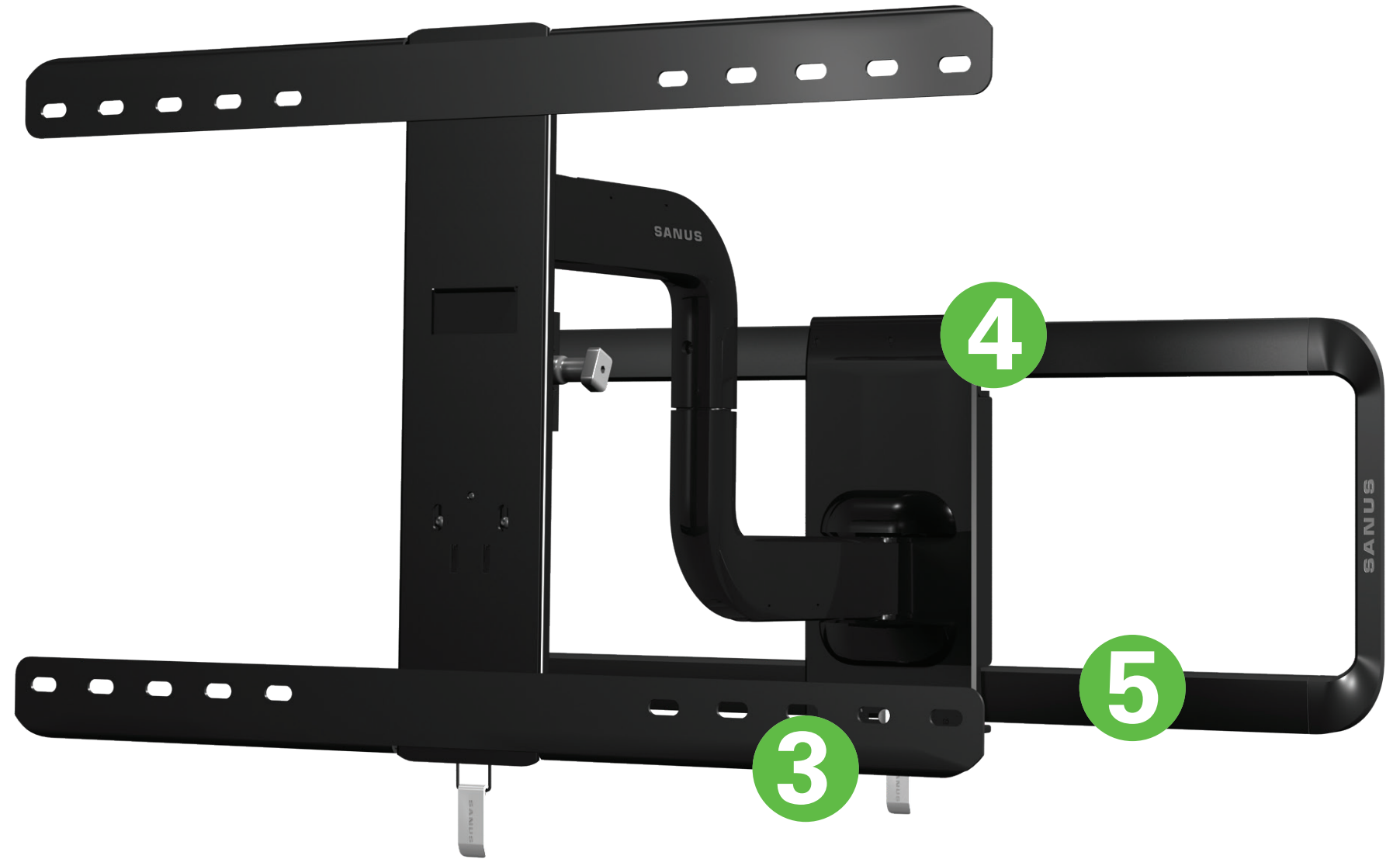

FRONT VIEW

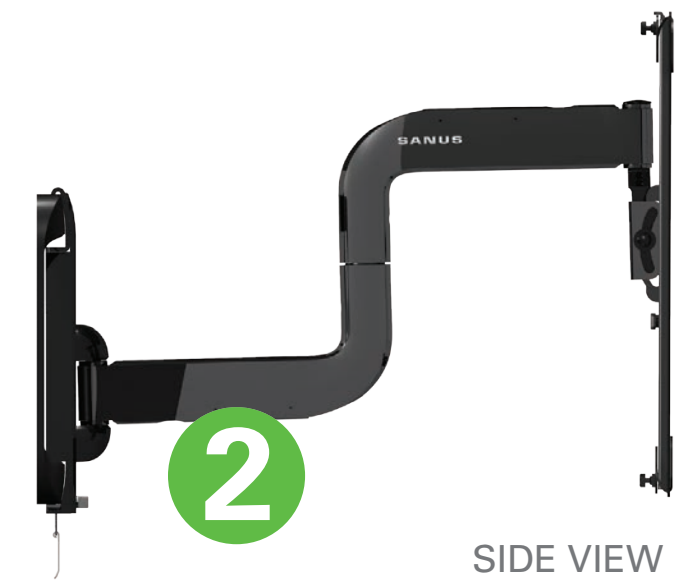

SIDE VIEW

VLF515

51"-70"

Weight Capacity 125 lbs.

- Wall Mount Tilts $-15^{\circ}/+5^{\circ}$
- Wall Mount Swivels $\pm 90^{\circ}$
- Distance from Wall 3.6"
- Extends 15" from Wall
- Product Width 30.8"
- Product Height 19.4"
- Product Depth 3.6"-15"
- Level Adjustment $\pm 3^{\circ}$



Tool-free mount assembly ensures a quick installation



Organize and conceal unsightly cables



Locking lever easily secures mount and audible click means mounting is complete

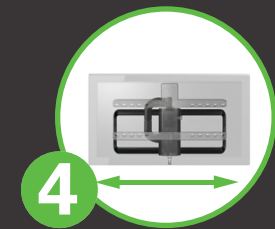

For perfect positioning on the wall, slide TV side to side



Decorative cover hides hardware for a finished look



FULL-MOTION

Adds tilt & swivel for reduced glare and the best view from any seat in the room

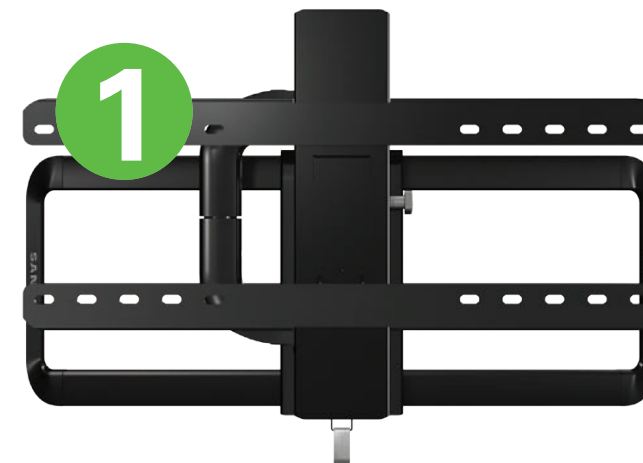
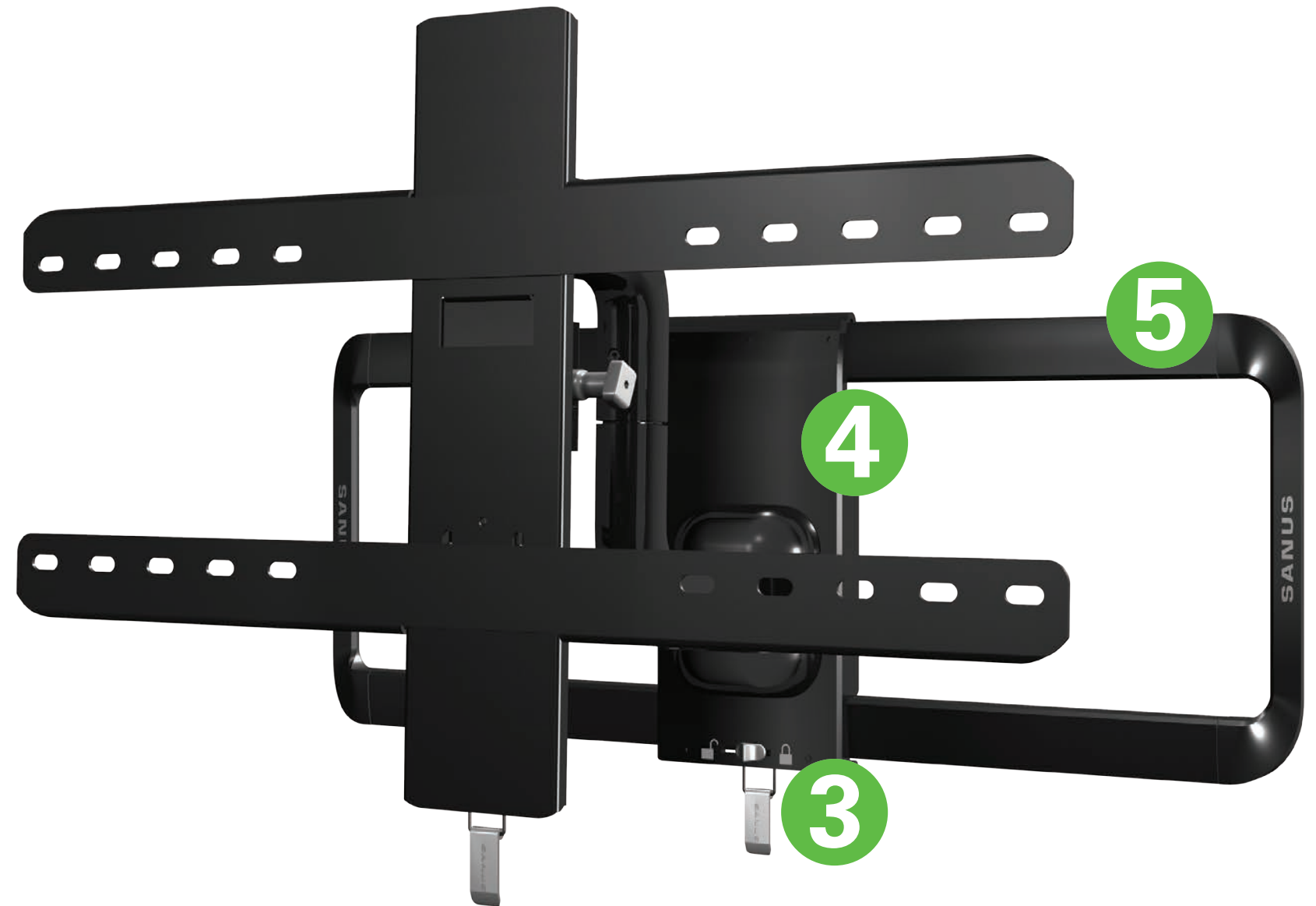

FRONT VIEW



SIDE VIEW

VMF518 | 40"-50" Weight Capacity 75 lbs.

- Wall Mount Tilts $\pm 12^\circ$
- Wall Mount Swivels $\pm 90^\circ$
- Distance from Wall 3.3"
- Extends 18.9" from Wall
- Product Width 17.2"
- Product Height 19"
- Product Depth 3.3"-18.9"
- Level Adjustment $\pm 95^\circ$



Tool-free mount assembly ensures a quick installation



Organize and conceal unsightly cables

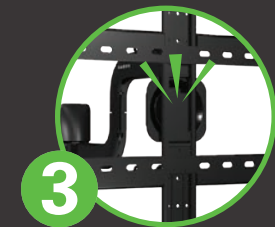

Locking lever easily secures mount and audible click means mounting is complete



Pivoting head enables easy adjustments after installation



Expandable TV brackets ensure a perfect fit



FULL-MOTION+

Adds tilt & extra swivel for reduced glare and the best view from any seat in the room

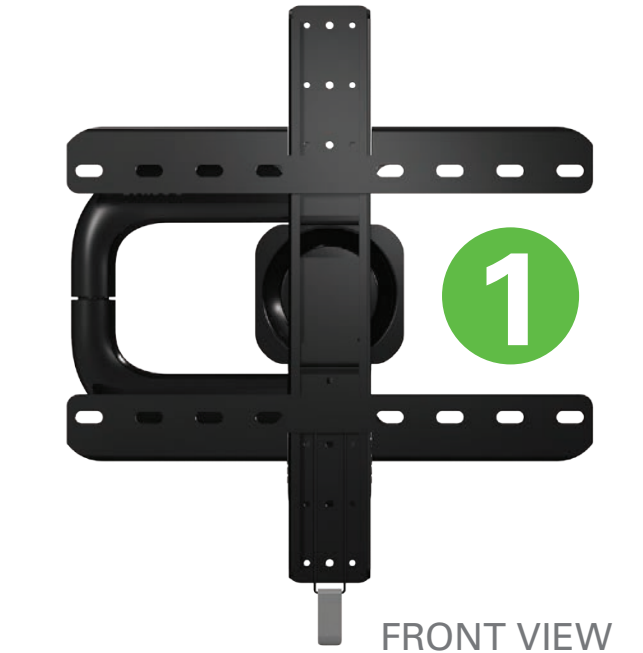

VSF415

13"-39"
Weight Capacity 50 lbs.

- Wall Mount Tilts $\pm 15^\circ$
- Wall Mount Swivels $\pm 90^\circ$
- Distance from Wall 3.5"
- Extends 15.3" from Wall
- Product Width 11"
- Product Height 11.51"
- Product Depth 3.3"-15.3"
- Level Adjustment $\pm 177^\circ$



1 VESA-compatible faceplate fits most 13"-39" flat panel TVs

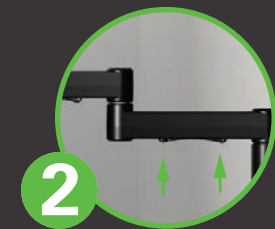

2 Organize and conceal unsightly cables

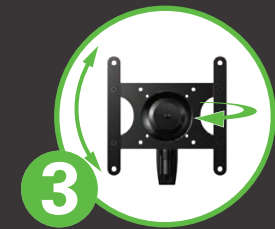

3 Virtual Axis 3D™ enables both landscape and portrait viewing, and post-install level adjustments



4 Tool-free mount assembly ensures a quick installation

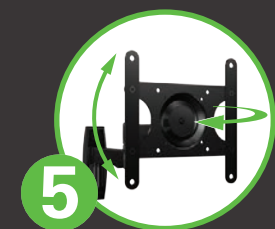

5 Tilt or swivel TV for perfect viewing from couch or floor



FULL-MOTION+

Adds tilt & extra swivel for reduced glare and the best view from any seat in the room

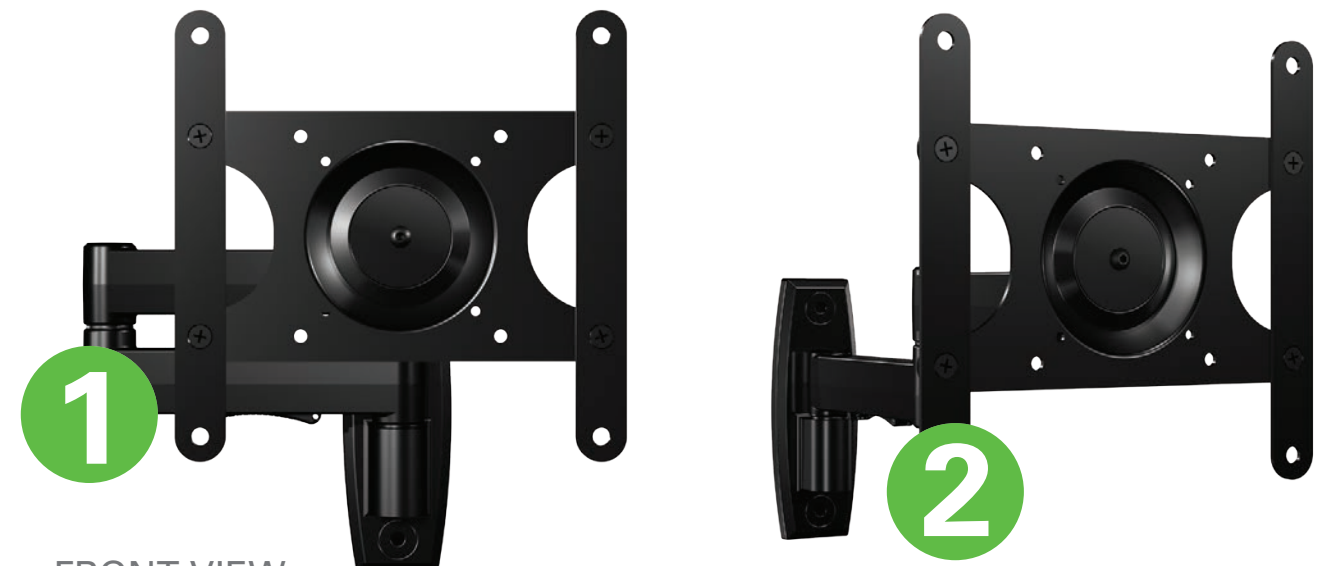
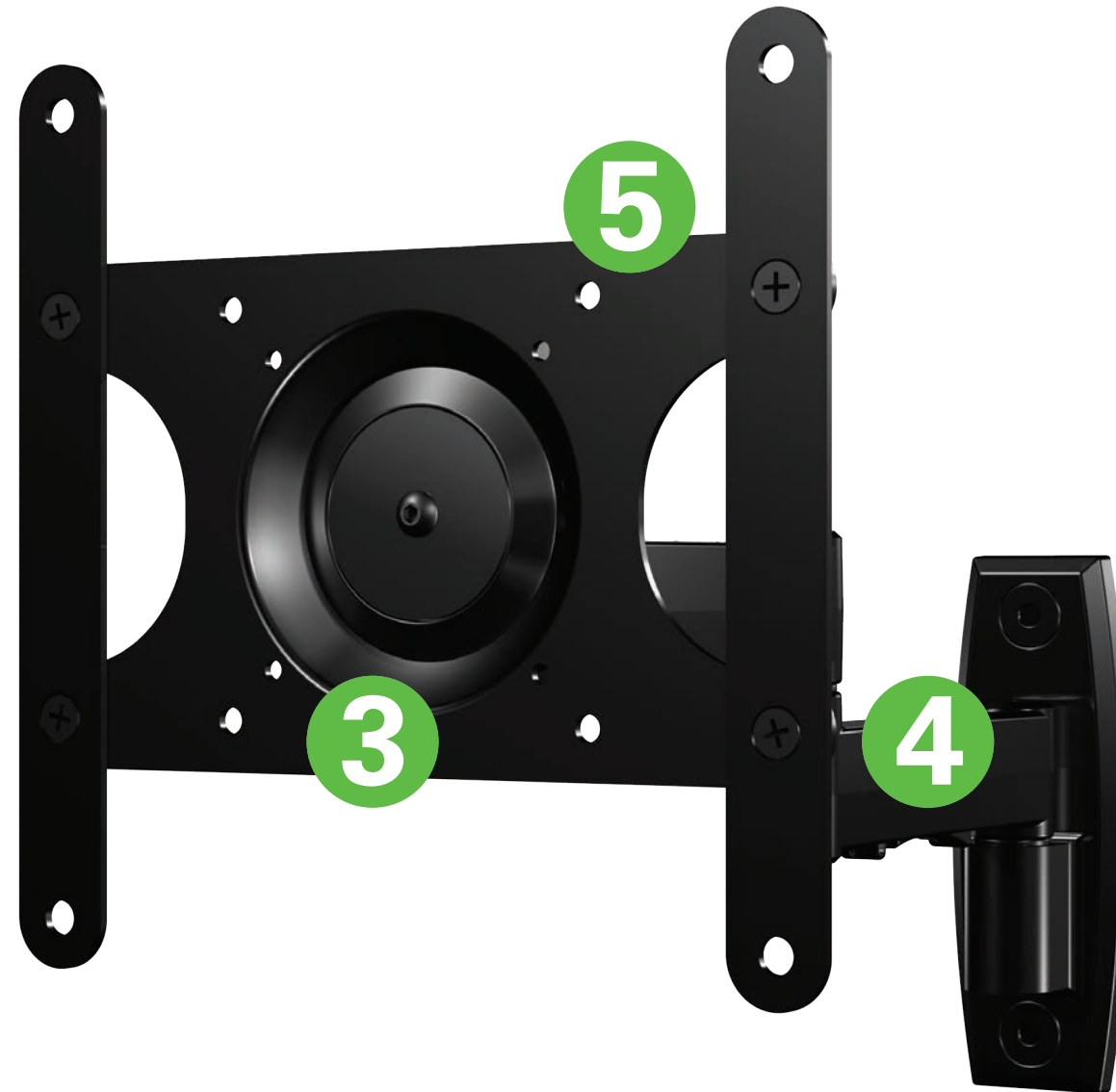

FRONT VIEW

VSF409

13"-39"

Weight Capacity 50 lbs.

- Wall Mount Tilts $\pm 15^\circ$
- Wall Mount Swivels $\pm 90^\circ$
- Distance from Wall 3.4"
- Extends 9.4" from Wall

- Product Width 11.6"
- Product Height 9.4"
- Product Depth 3.4"-9.4"
- Level Adjustment $\pm 177^\circ$



VESA-compatible faceplate fits most 13"-39" flat panel TVs

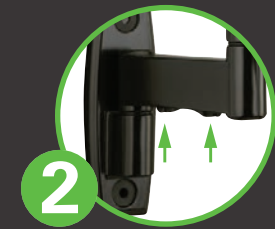

Organize and conceal unsightly cables



Virtual Axis 3D™ enables both landscape and portrait viewing, and post-install level adjustments



Easily adjust TV without tools



Tilt or swivel TV for perfect viewing from couch or floor



FULL-MOTION

Adds tilt & swivel for reduced glare and the best view from any seat in the room



FRONT VIEW



VLT5

51"-80"
Weight Capacity 125 lbs.

- Wall Mount Tilts -12°/+7°
- Product Width 30.8"
- Distance from Wall 2.1"
- Product Height 17.7"
- Product Depth 2.1"
- Level Adjustment .5"



Allows fine-tuning after installation

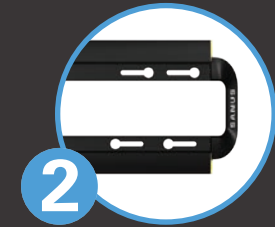

Built-in keyhole in wall plate allows for simple, single-person installation

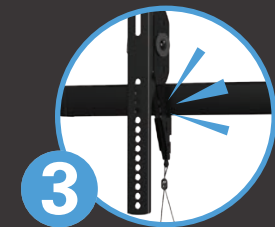

Locking lever easily secures mount and audible click means mounting is complete

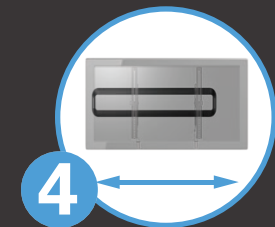

For perfect positioning on the wall, slide TV side to side



Mount tilts TV back to allow for easy cable access



TILTING

Adds tilt for reduced glare from lights and windows

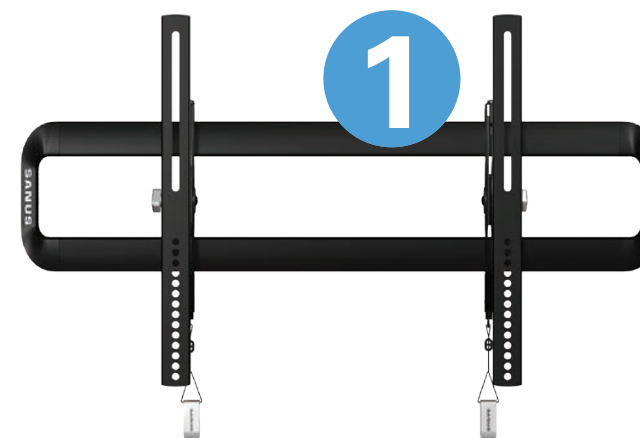
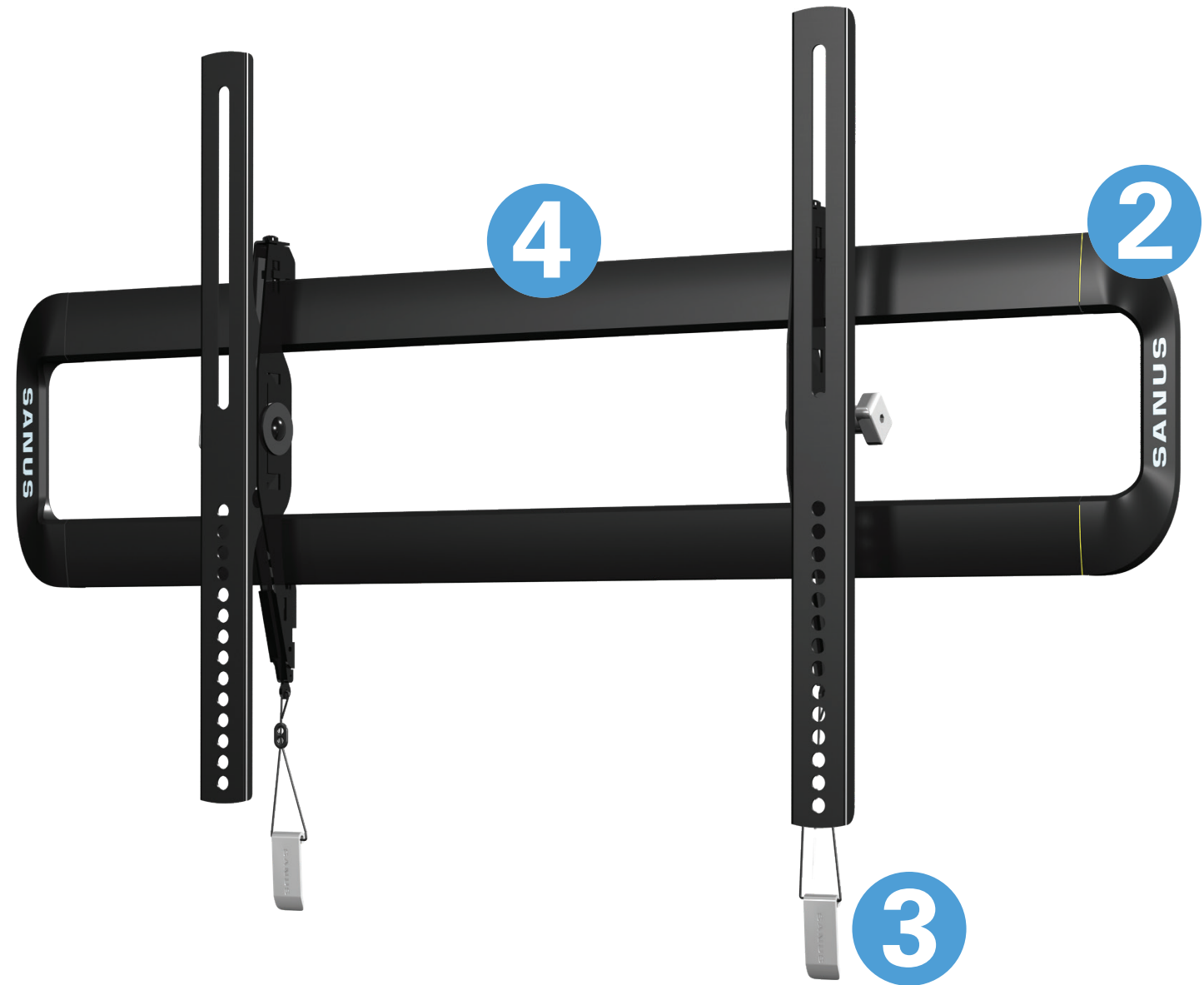

FRONT VIEW



SIDE VIEW

VMT5

40"-50"
Weight Capacity 75 lbs.

Wall Mount Tilts -12°/+7°
Distance from Wall 2.1"

Product Width 25.8"
Product Height 17.7"
Product Depth 2.1"
Level Adjustment .5"



Allows fine-tuning after installation



Built-in keyhole in wall plate allows for simple, single-person installation

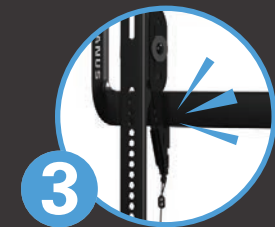

Locking lever easily secures mount and audible click means mounting is complete

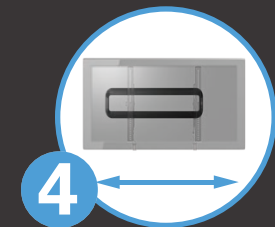

For perfect positioning on the wall, slide TV side to side



Mount tilts TV back to allow for easy cable access

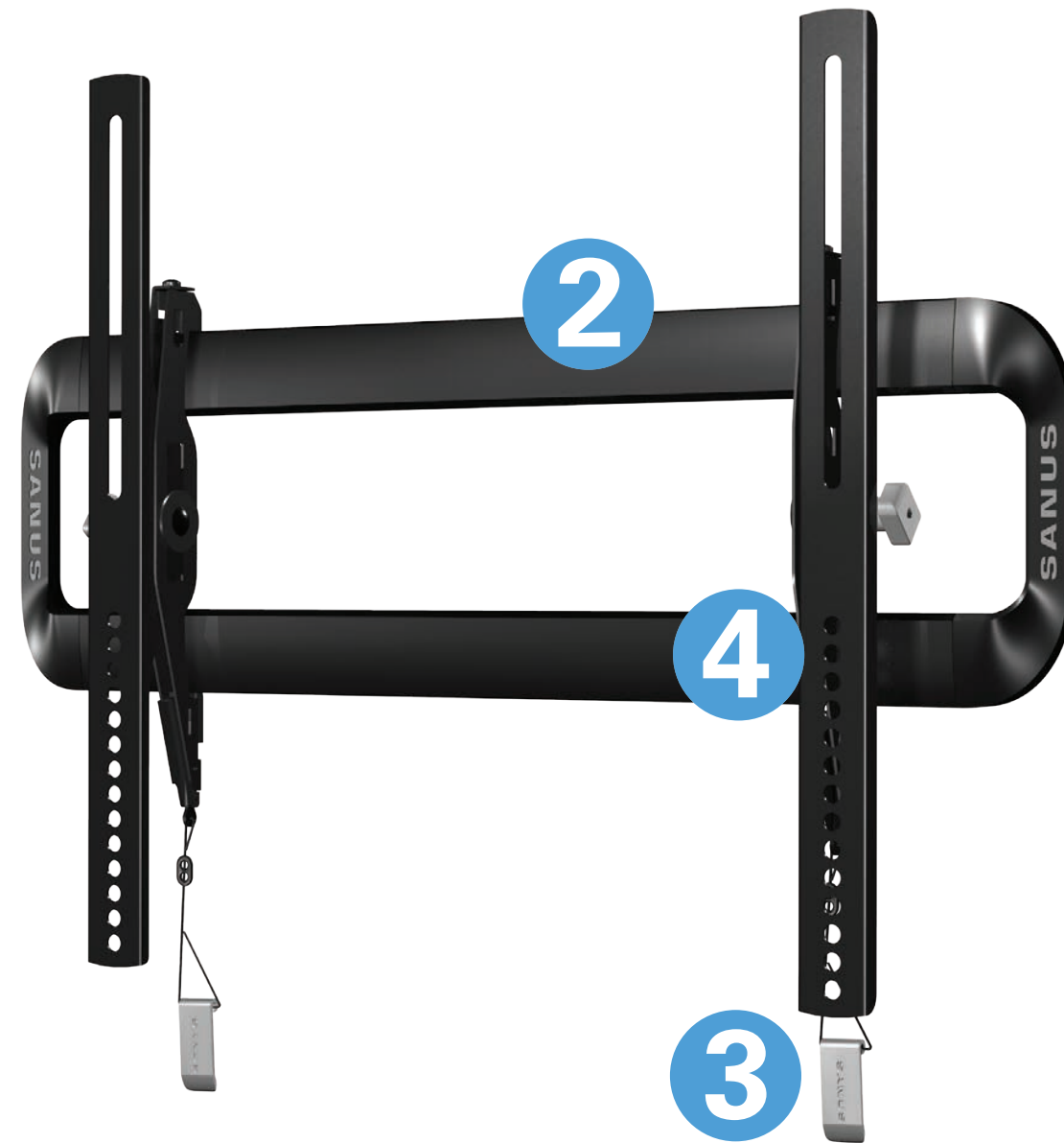

TILTING

Adds tilt for reduced glare from lights and windows

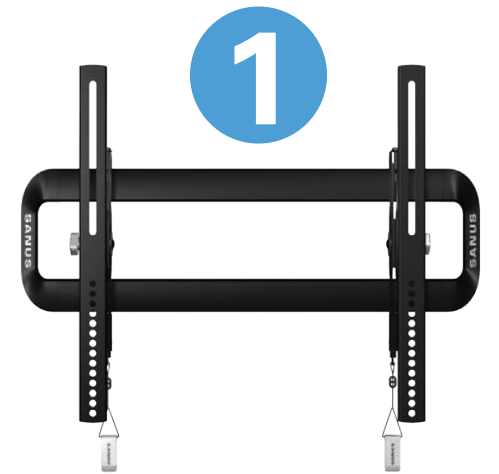

FRONT VIEW



SIDE VIEW

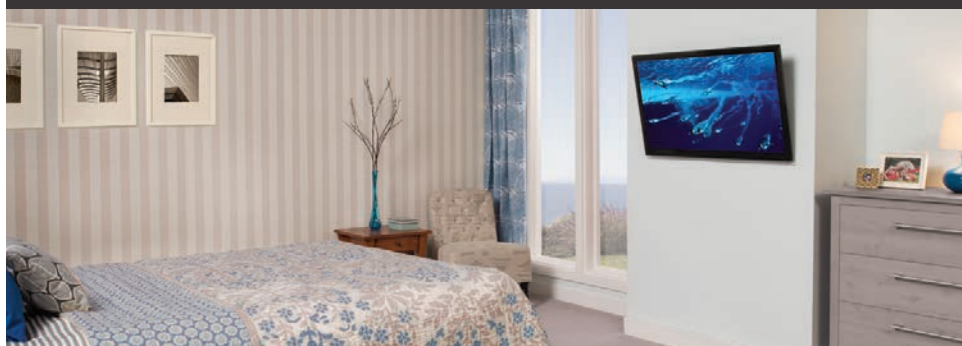

VST4

13"-39"
Weight Capacity 50 lbs.

Wall Mount Tilts $\pm 12^\circ$
Distance from Wall 1.7"

Product Width 8.8"
Product Height 8.8"
Product Depth 1.7"
Level Adjustment $\pm 2^\circ$



Tool-free mount assembly ensures a quick installation



Locking lever easily secures mount and audible click means mounting is complete

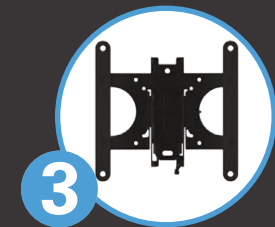

VESA-compatible faceplate fits most 13"-39" flat panel TVs



Easily adjust TV without tools



Mount tilts TV back to allow for easy cable access

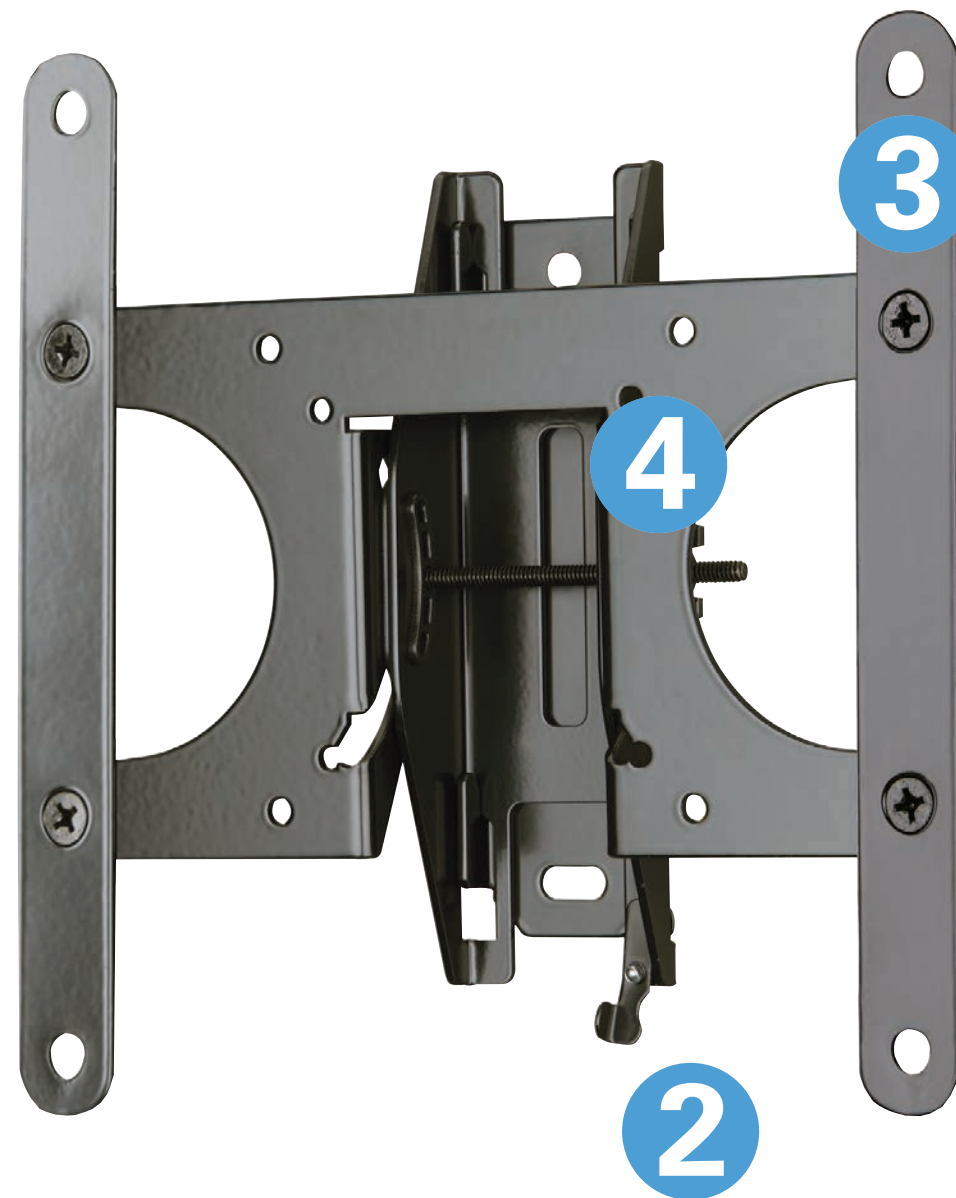

TILTING

Adds tilt for reduced glare from lights and windows

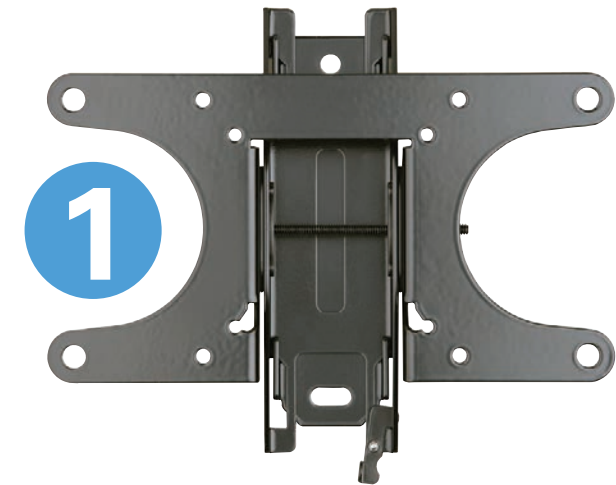

FRONT VIEW



SIDE VIEW



VLL5

51"-80"
Weight Capacity 125 lbs.

Distance from Wall 0.9"

Product Width 30"

Product Height 18.7"

Product Depth 0.9"

Level Adjustment .5"



1 Allows fine-tuning after installation



2 Built-in keyhole in wall plate allows for simple, single-person installation



3 Safety tab and click stand provide a secure connection and easy access to cables

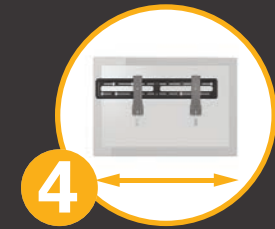

4 For perfect positioning on the wall, slide TV side to side



5 Tool-free mount assembly ensures a quick installation



FIXED-POSITION

Safely secures TV almost flush with the wall

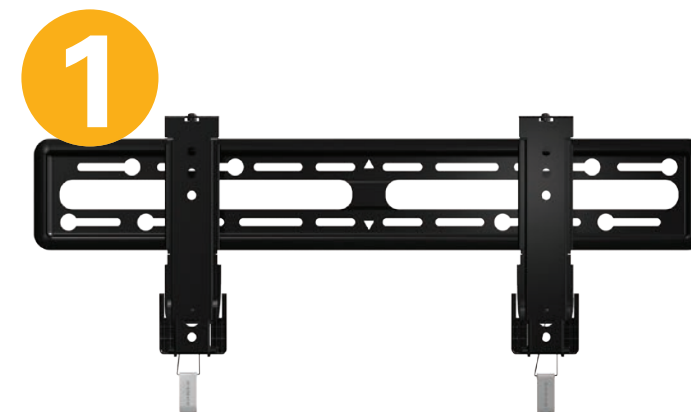
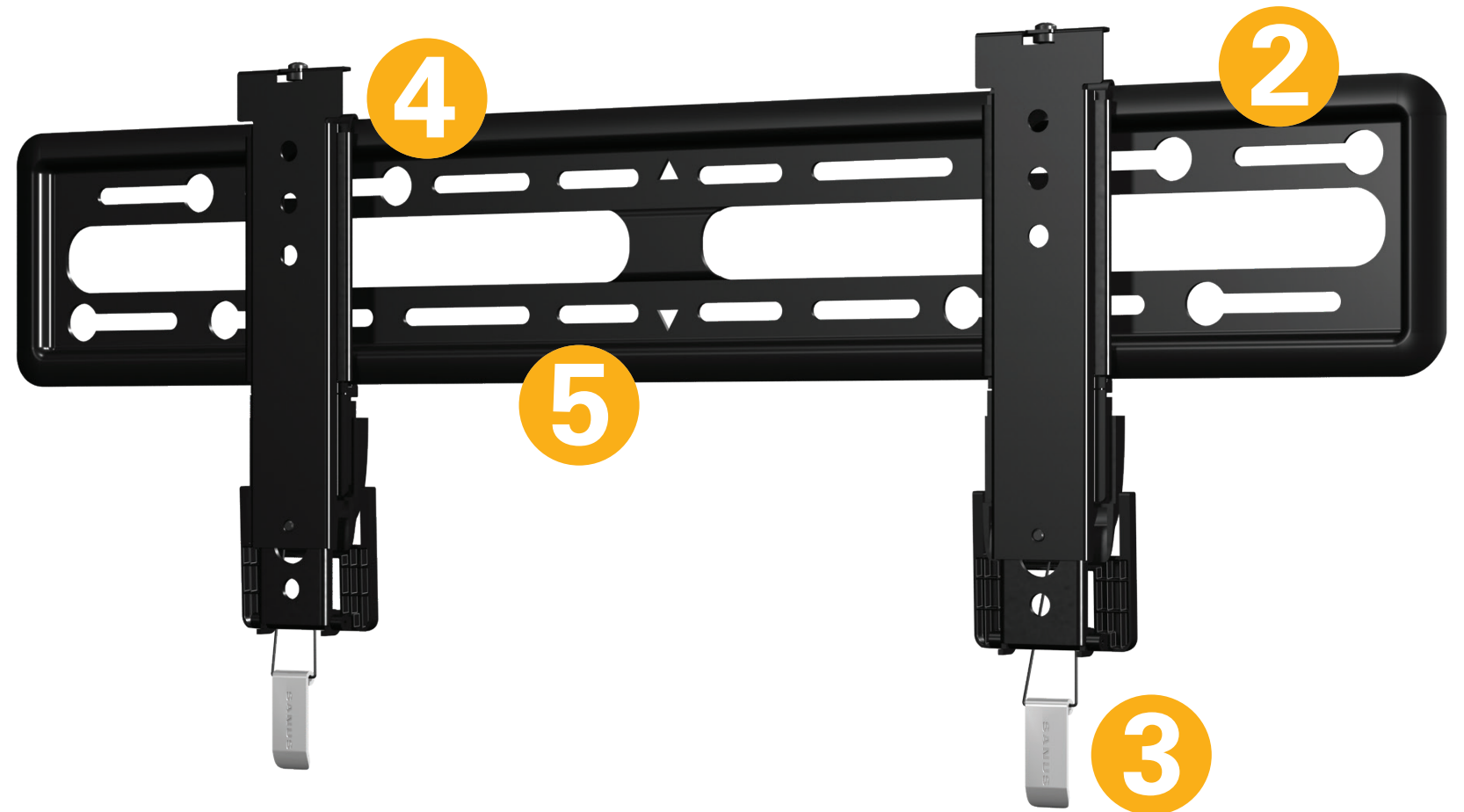

FRONT VIEW



SIDE VIEW

VML5

40"-50"
Weight Capacity 75 lbs.

↳ Distance from Wall 0.9"

⊞ Product Width 21.3"

Product Height 18.7"

Product Depth 0.9"

Level Adjustment .5"



Allows fine-tuning after installation



Built-in keyhole in wall plate allows for simple, single-person installation



Safety tab and click stand provide a secure connection and easy access to cables

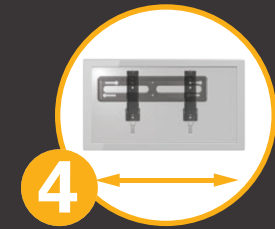

For perfect positioning on the wall, slide TV side to side



Tool-free mount assembly ensures a quick installation

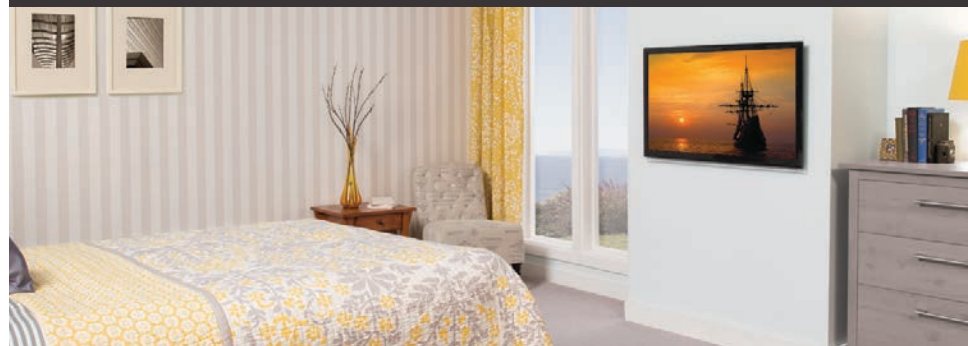

FIXED-POSITION

Safely secures TV almost flush with the wall

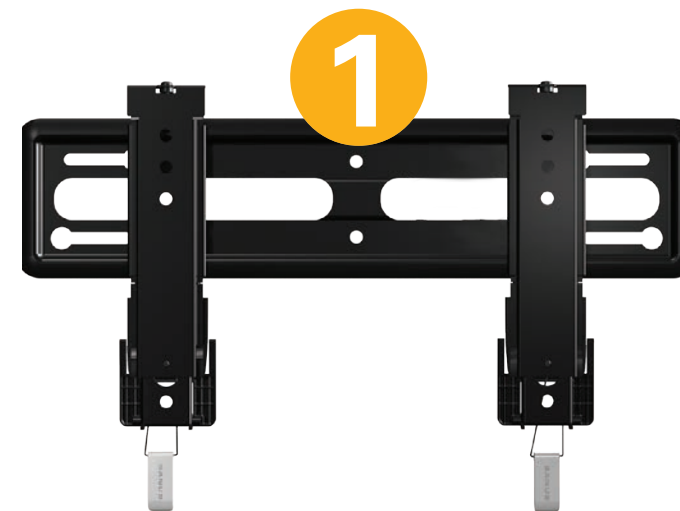
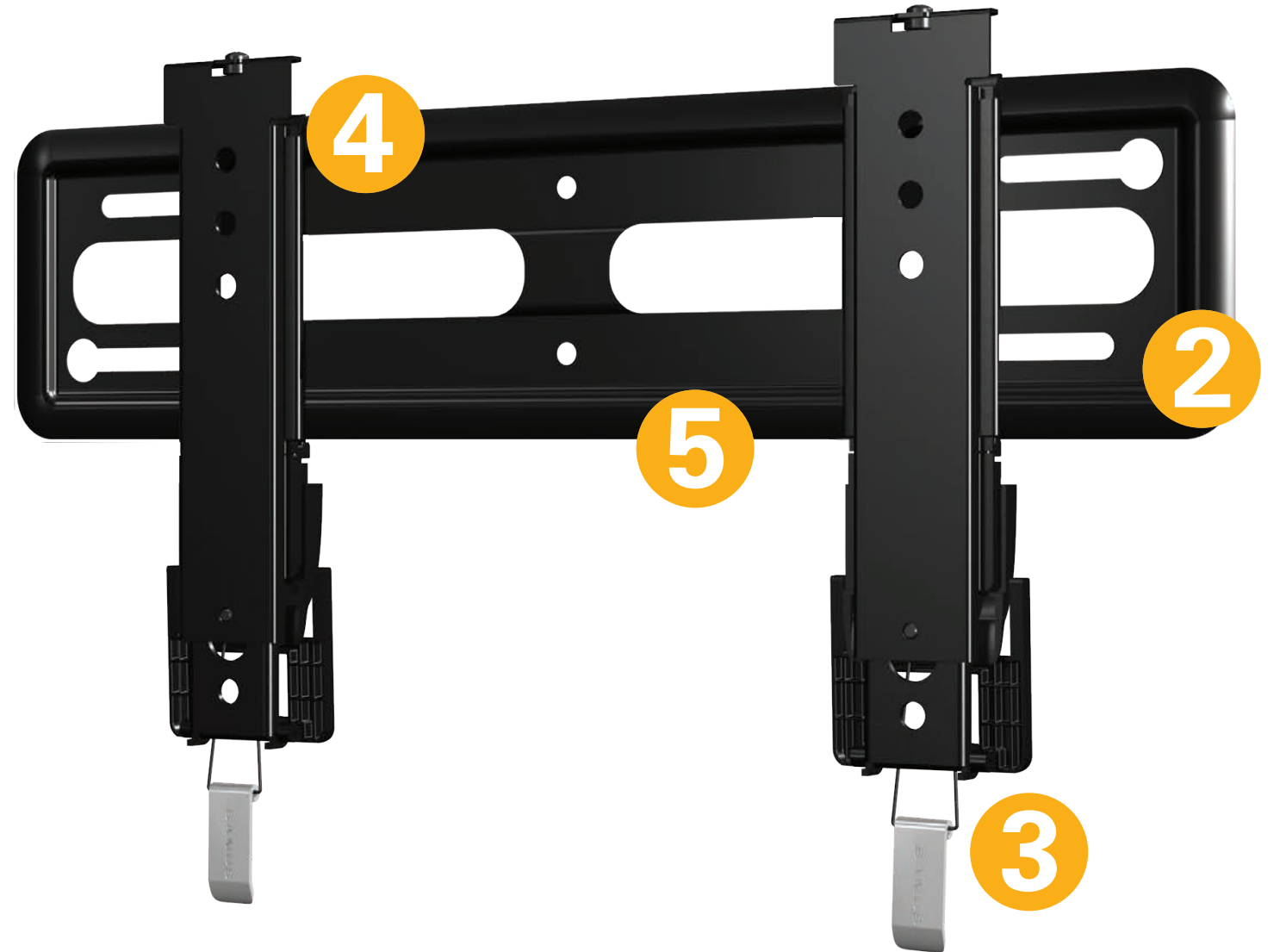

FRONT VIEW



SIDE VIEW

VSL4

13"-39"
Weight Capacity 50 lbs.

↳ Distance from Wall 0.6"

Product Width 10"
Product Height 8.8"
Product Depth 0.6"

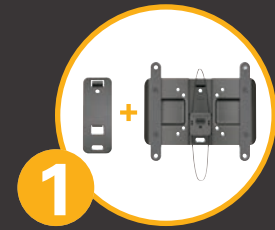

Tool-free mount assembly ensures a quick installation

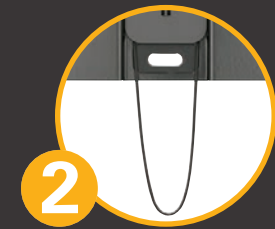

Safety lock mechanism provides a safe and easy connection

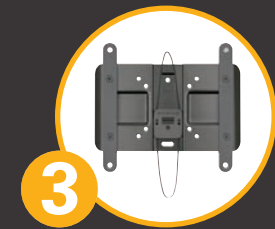

VESA-compatible faceplate fits most 13"-39" flat panel TVs



Perfect for viewing TV at eye level

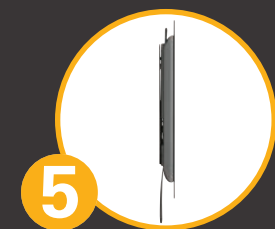

Position TV as close to the wall as possible



FIXED-POSITION

Safely secures TV almost flush with the wall

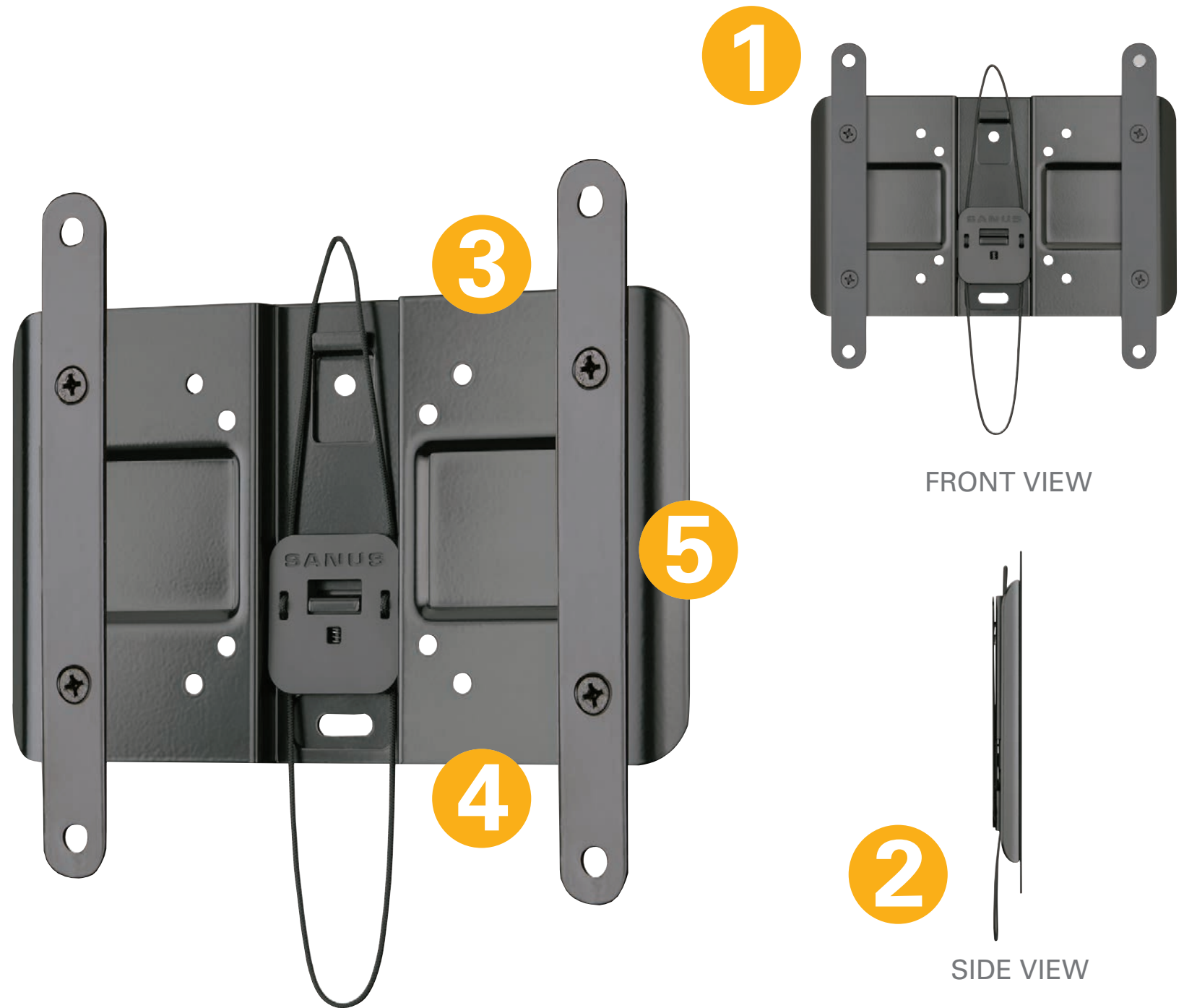

AV ACCESSORIES

Model **SA304** | On-Wall Cable Management

- Conceals and organizes unsightly AV cables against wall
- Paint and cut cable tunnels to match any home's design theme
- Perfect addition for a mounted TV to create a finished, professional look



Model **SA808** | Recessed Component Box

- Designed specially for use with the SANUS SA206 EcoSystem™ Mini
- Routes AV cables through the wall for a perfect, finished look
- Fits perfectly behind mounted TVs or furniture
- Easy DIY installation, no additional wiring or electrician needed



Model **SA809** | Large Recessed Wall Box

- Designed specially for use with the SANUS SA206 EcoSystem™ Mini
- Routes AV cables through the wall for a perfect, finished look
- Fits perfectly behind mounted TVs or furniture
- Easy DIY installation, no additional wiring or electrician needed



Model **SA206** | EcoSystem™ Mini

- Protects AV components from damaging power surges
- Designed to work with most small components
- Space-saving design keeps components and cables neat and tidy
- Easily concealed behind mounted TVs and furniture

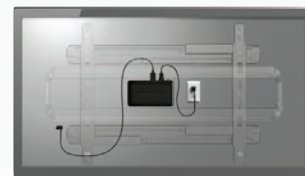

Model **SA405** | Soundbar Speaker Mount

- Mounts soundbar for a finished, professional look
- Attaches directly to the bottom of a TV mount
- Works with most mountable soundbars
- Easy to assemble; all necessary hardware included

